

PSA
gives you
a lift

PSA
000000000000

Fly away with
PSA

COLORING

&

PUZZLE
BOOK

1

12

2

This is a map of California. PSA has over 900 flights every week between northern and southern California. Draw a line connecting the numbers, starting with # 1.

3

11

(Draw a circle around the cities *you* have visited.)

• Sacramento

• San Francisco

• Oakland

• San Jose

4

5

6

• Hollywood-Burbank

10

• Ontario

• Los Angeles

7

• San Diego

9

8

Can you fly your jet plane from the airport to your house at the center of the circle?
(No fair crossing any lines!)

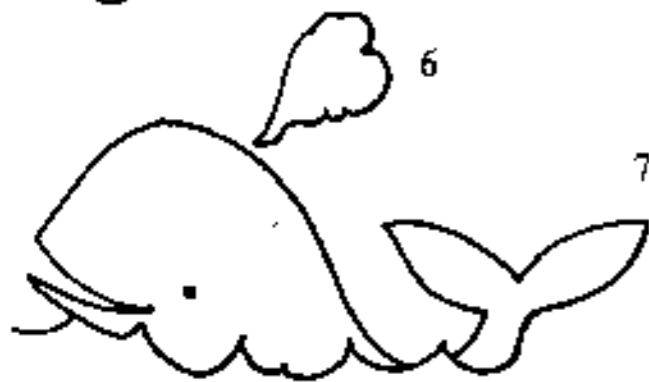
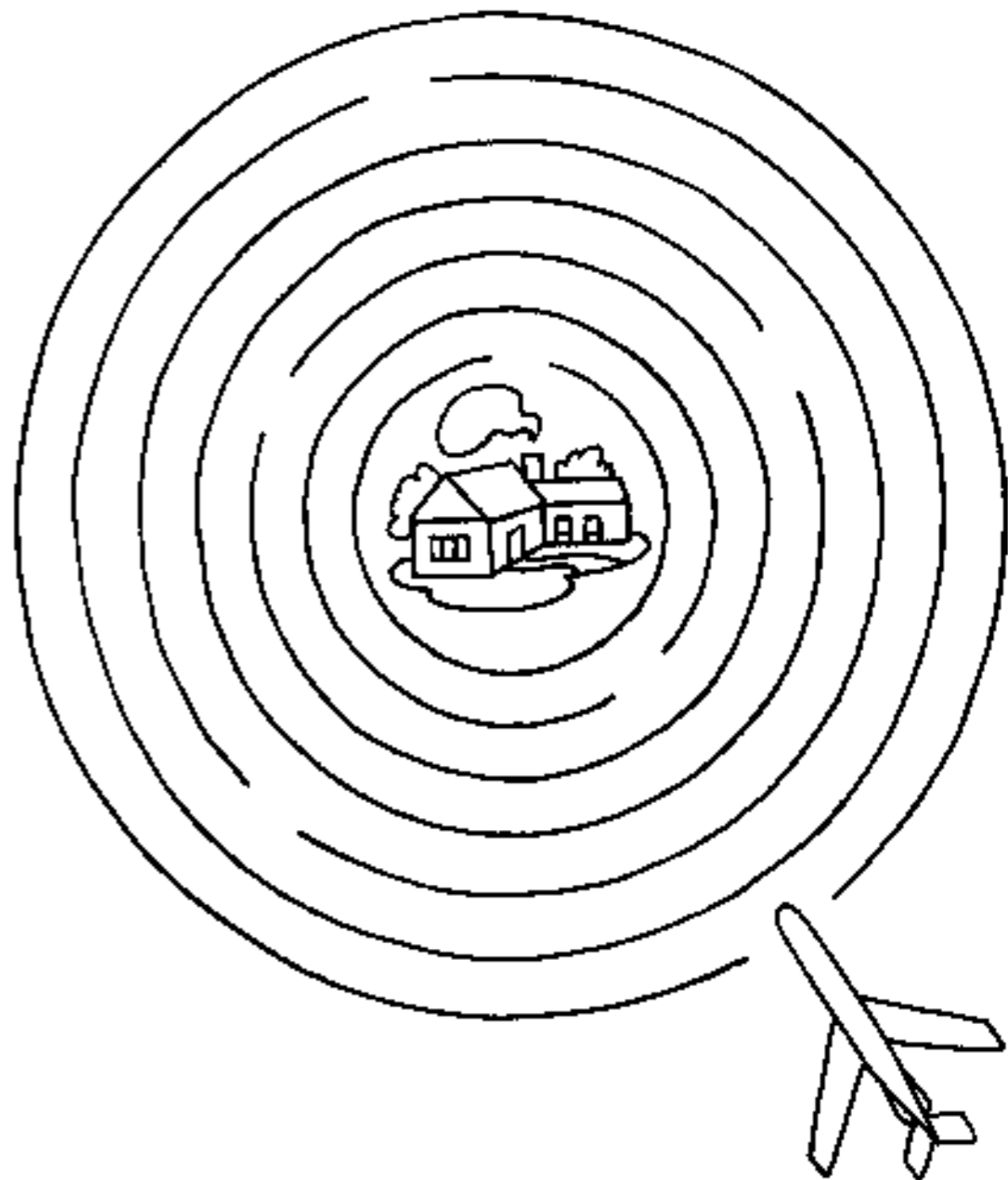

Two of these PSA stewardesses are twins. Can you guess which two? Draw a circle around them.

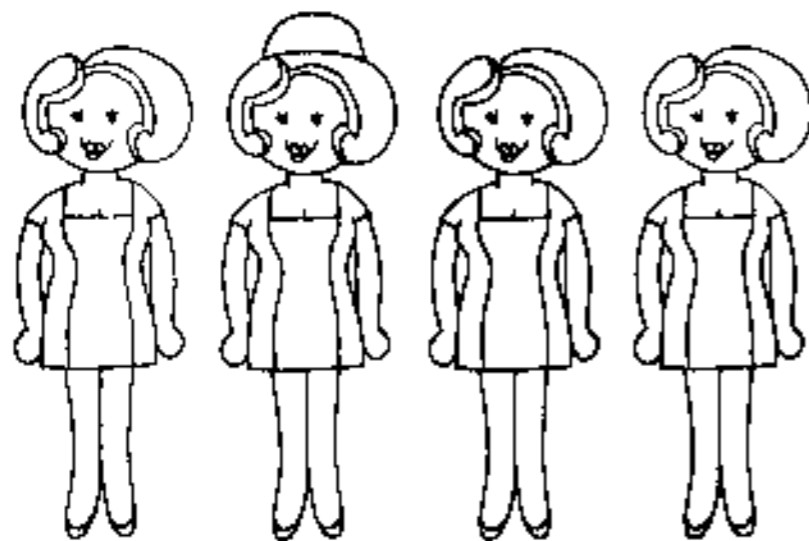
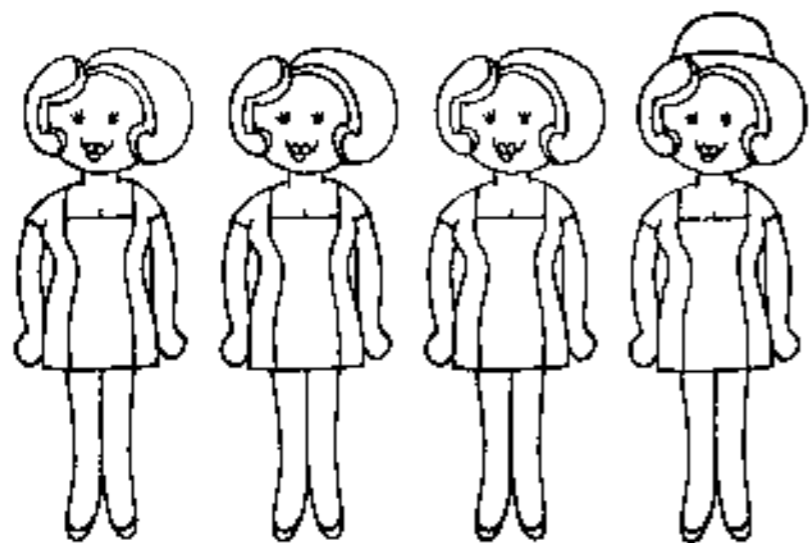

(If this is your first plane ride, ask your stewardess to give you a First Flight Certificate.)



Captain's wings. After you color them, cut them out and pin them on your shirt or dress.

These are the men who fly your airplane. The one in the middle, with four stripes, is the captain. Color the stripes gold. The other men are the co-pilot and the flight engineer.

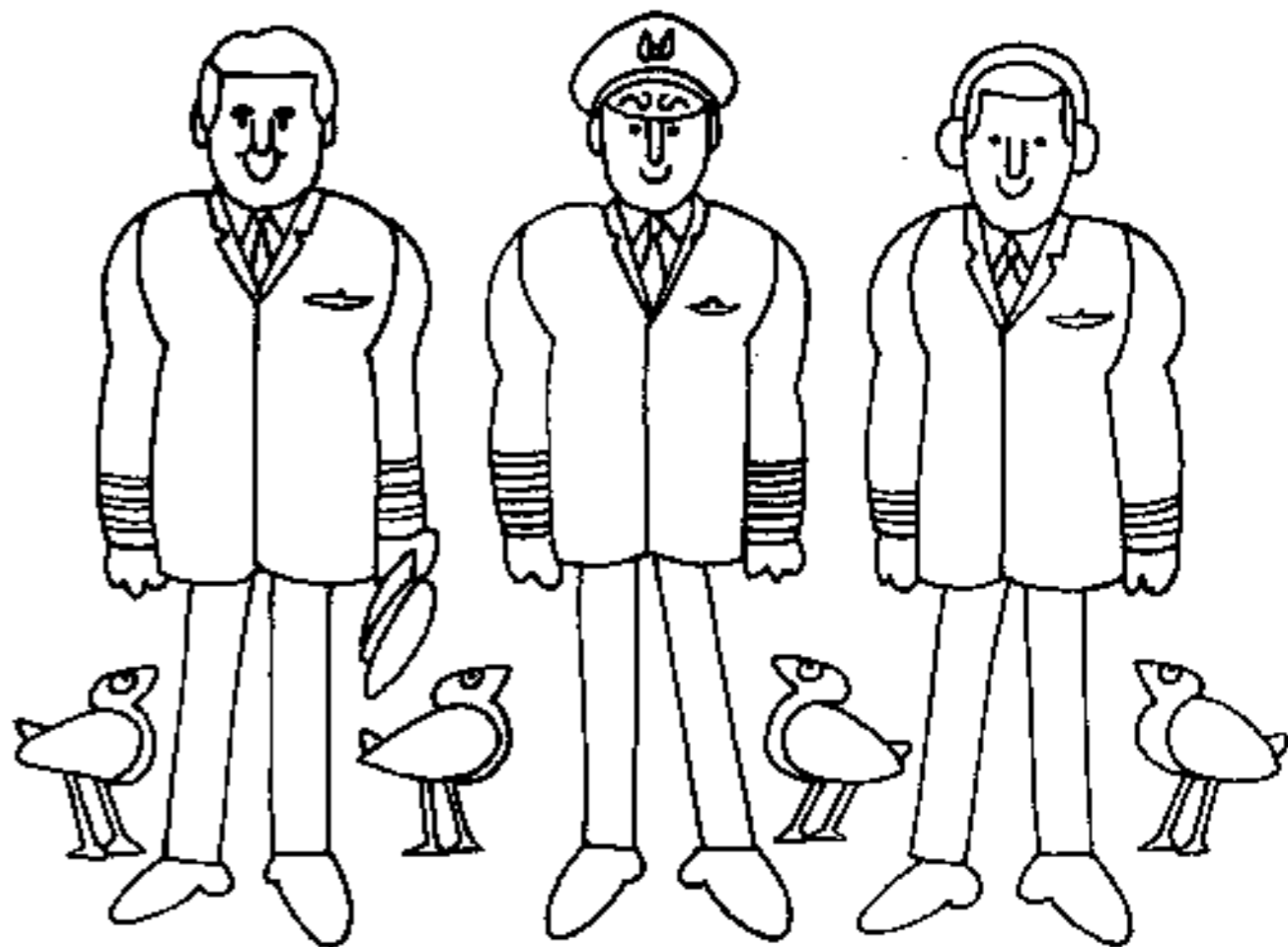

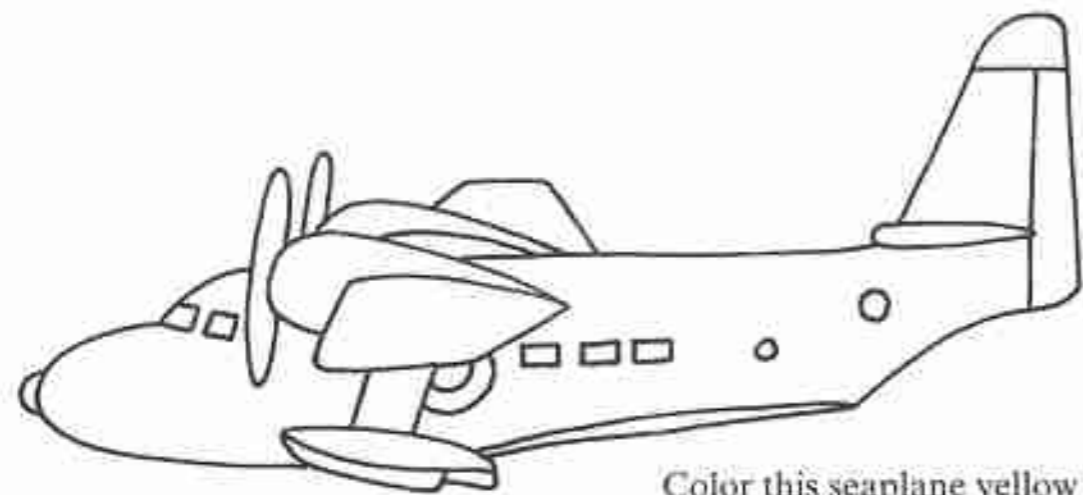

Color this seaplane yellow

FLY IN THE SKY There are many different ways to travel by air. Here are some pictures of interesting aircraft to color.

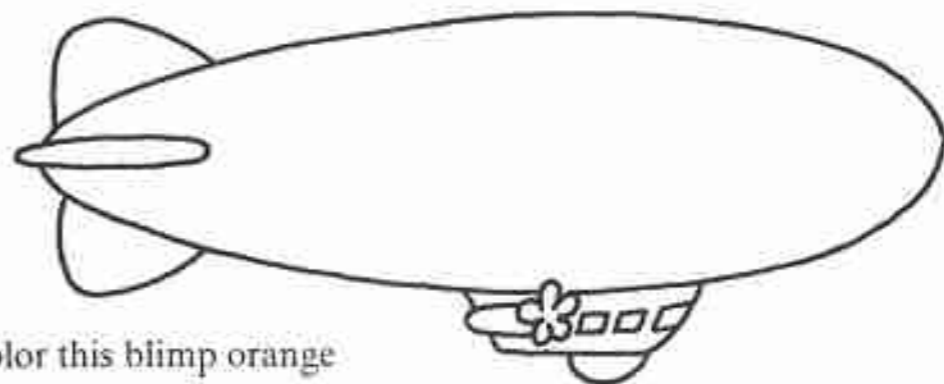

Color this blimp orange

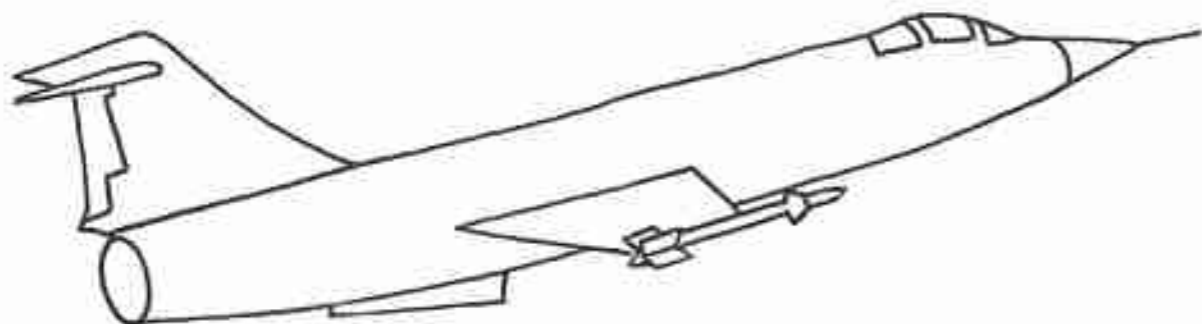

Color this jet fighter blue



Color this PSA super jet red

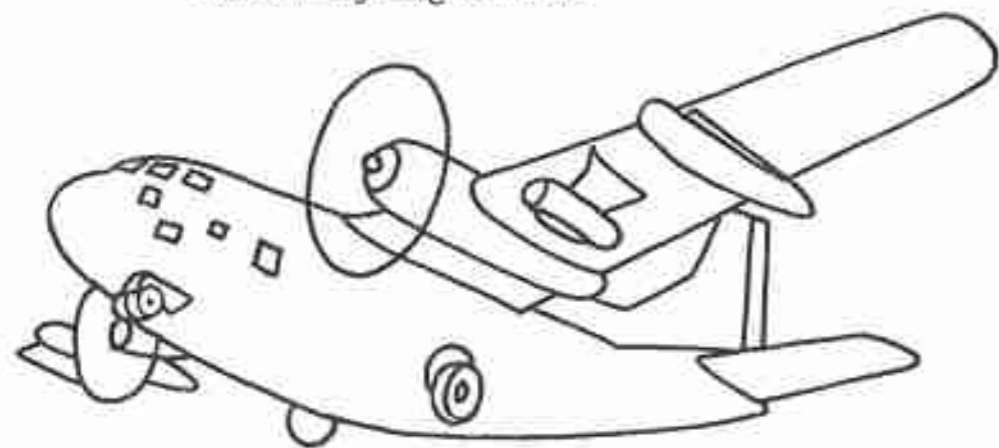

Color this cargo plane green



Color this helicopter purple

This is a picture of a PSA Super Jet. See if you can copy it below.

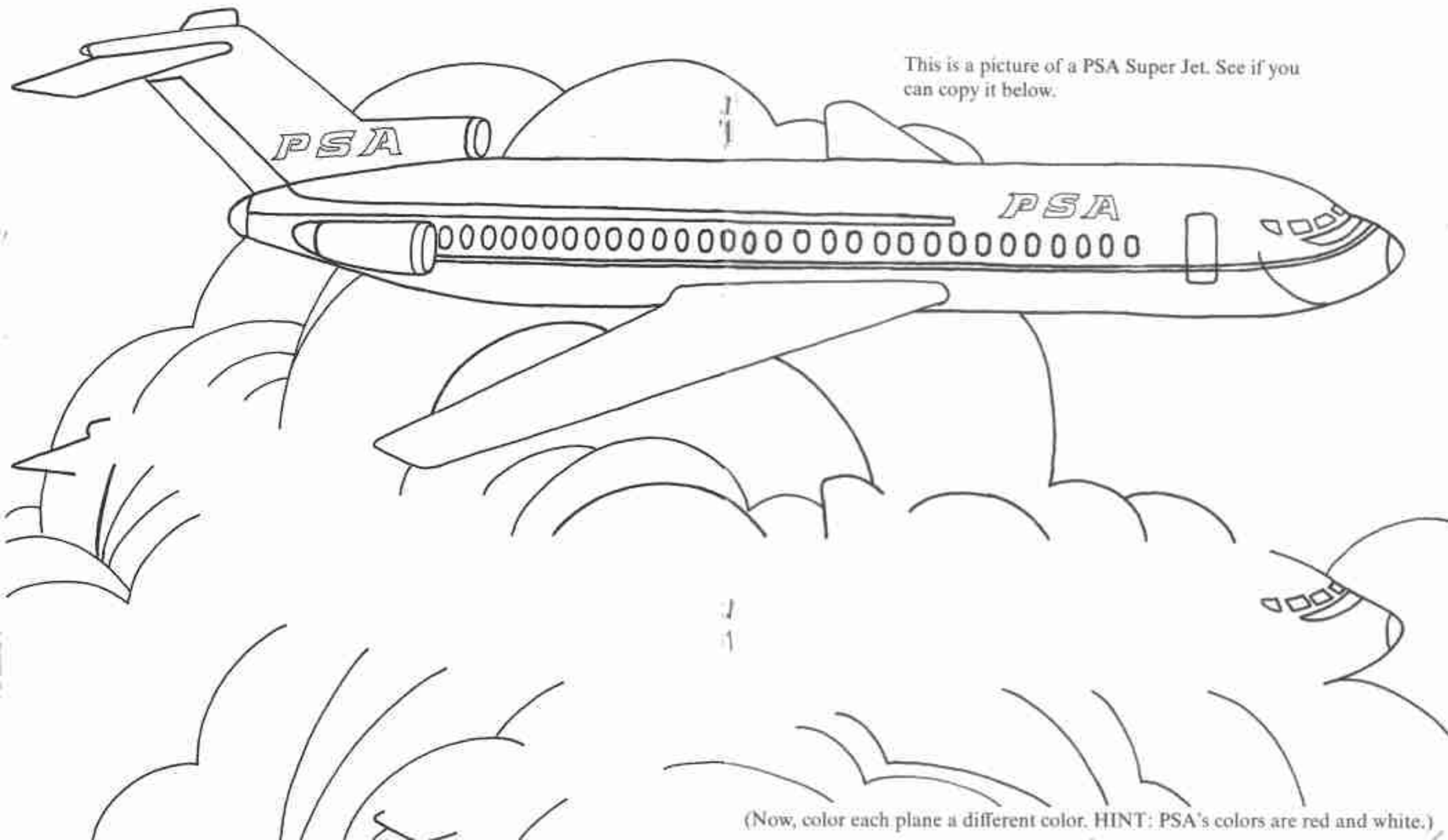

(Now, color each plane a different color. HINT: PSA's colors are red and white.)

Here's a coloring puzzle. Fill in the x-marked spaces in yellow and the o-marked spaces in red and you will find the surprise answer.

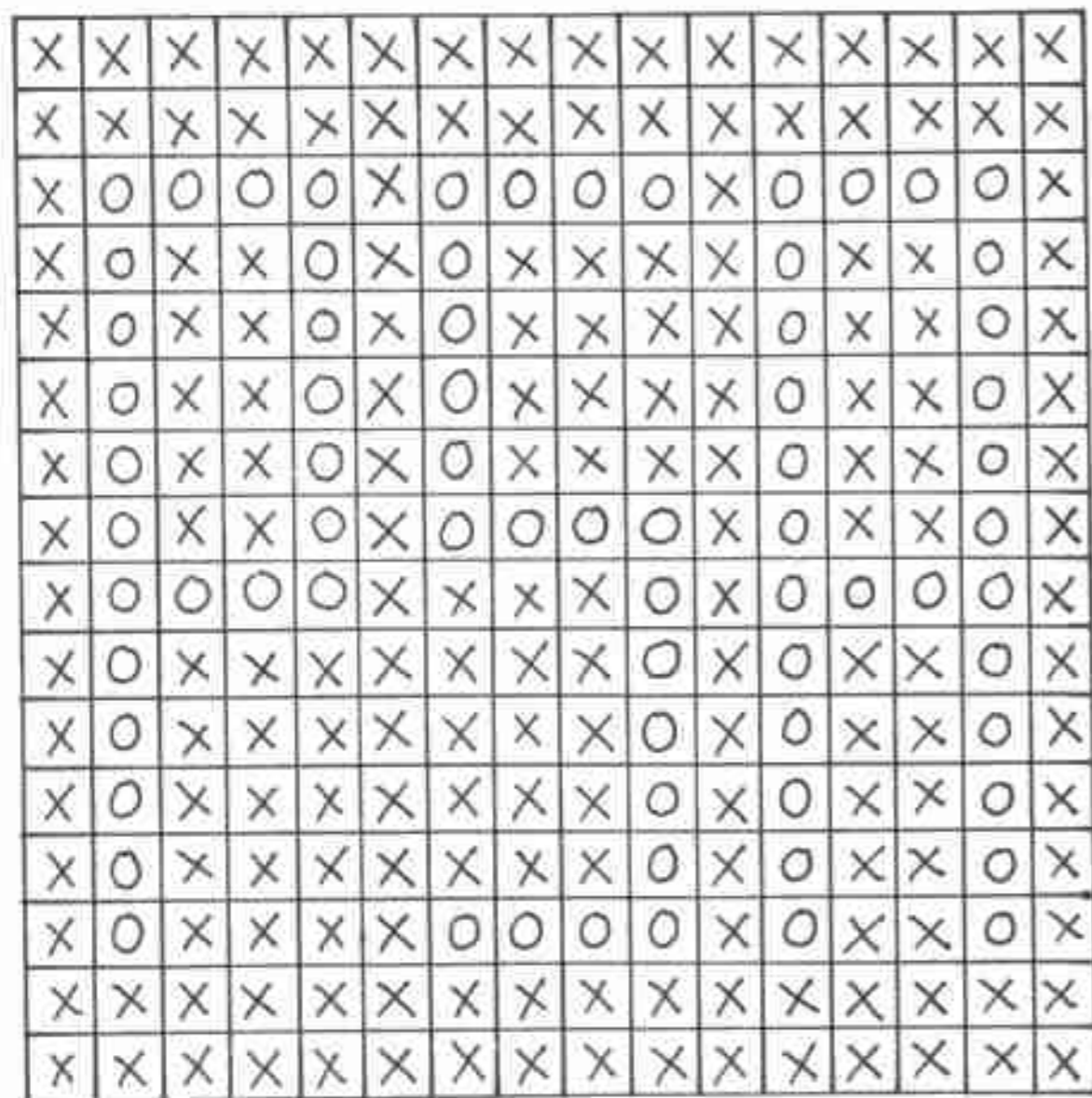

(Here's a clue: it flies 900 flights a week.)

These are some of the flags of the international code of signals. Each flag below has two just like it. Color the matching ones the same color.

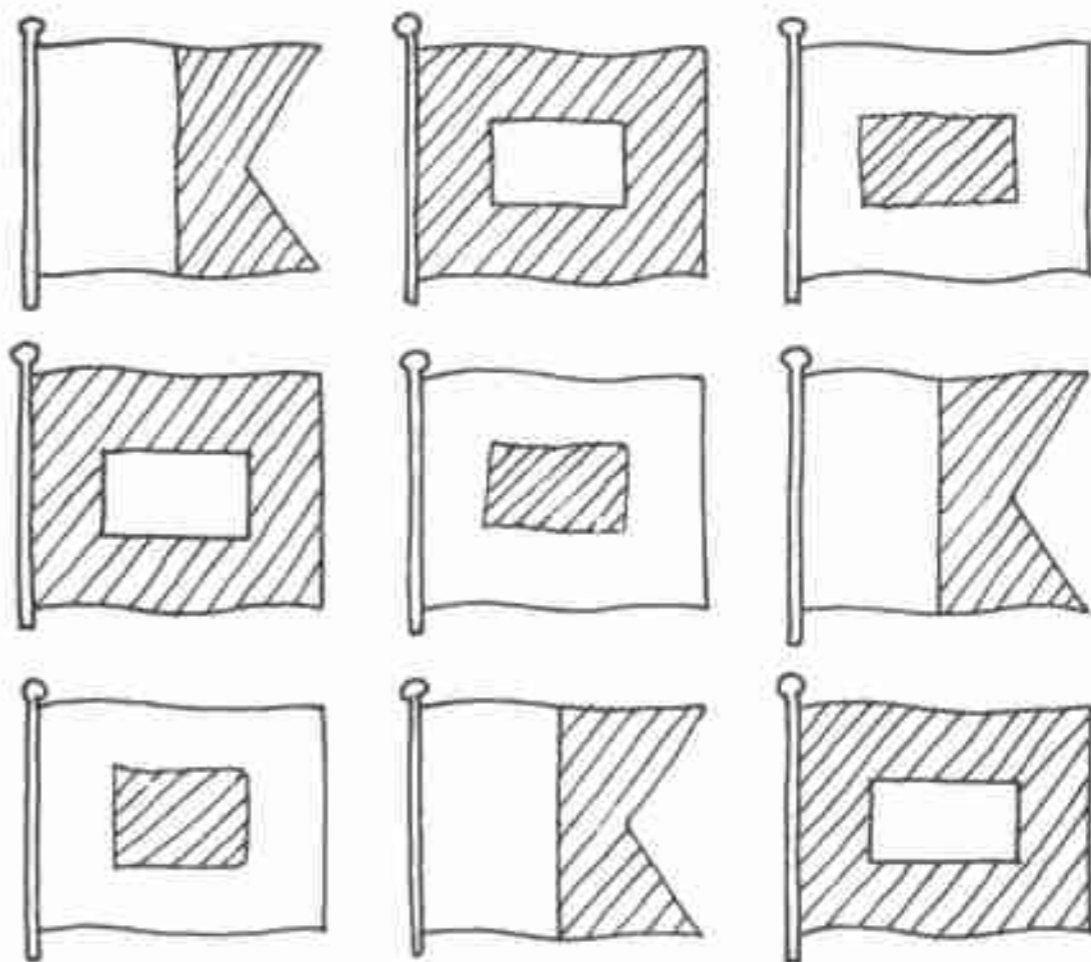

Ask your stewardess what the three different flags stand for.

Who uses what? Here are pictures of four different kinds of people. Draw a line to the things the mechanic, the stewardess, the flight engineer and the passenger use in their work.

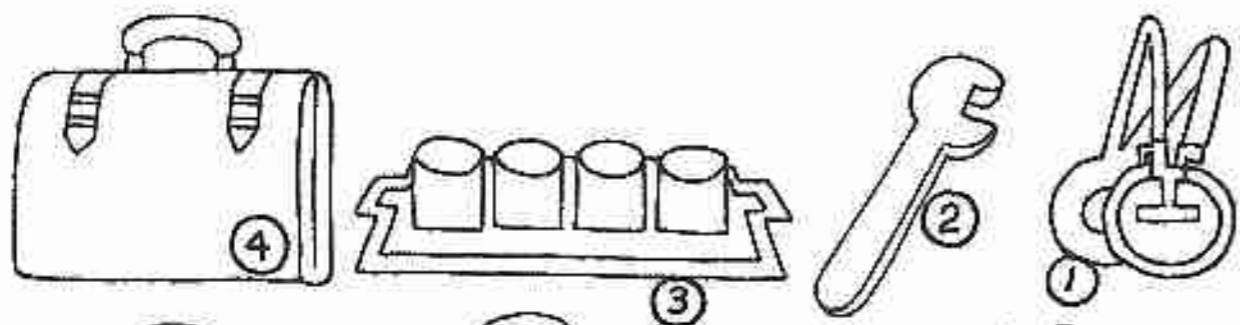

Knowing the exact time is as important to you as it is to a pilot. Can you tell what time it is on the pilot's clock?

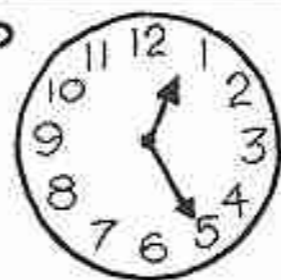

It is _____ o'clock. It is _____ o'clock. It is _____ o'clock.

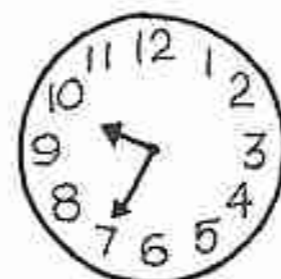
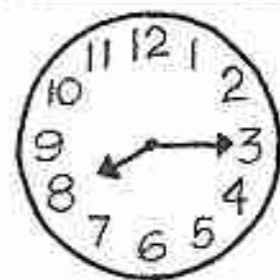

It is _____ o'clock. It is _____ o'clock. It is _____ o'clock.

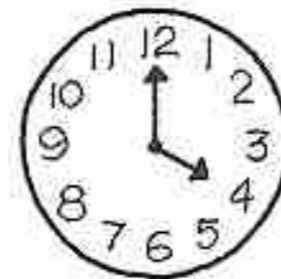
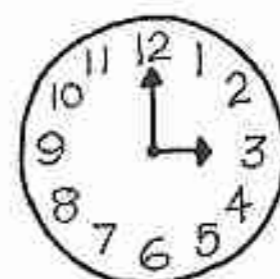

It is _____ o'clock. It is _____ o'clock. It is _____ o'clock.



The dot-dash-and box game. (You can play this with a friend.) Take turns joining two dots together with a line. The idea is to try to complete a box. When you complete the box, put your initial in it. When you complete a box, you get another turn. The winner is the player who has his initials in the most boxes.

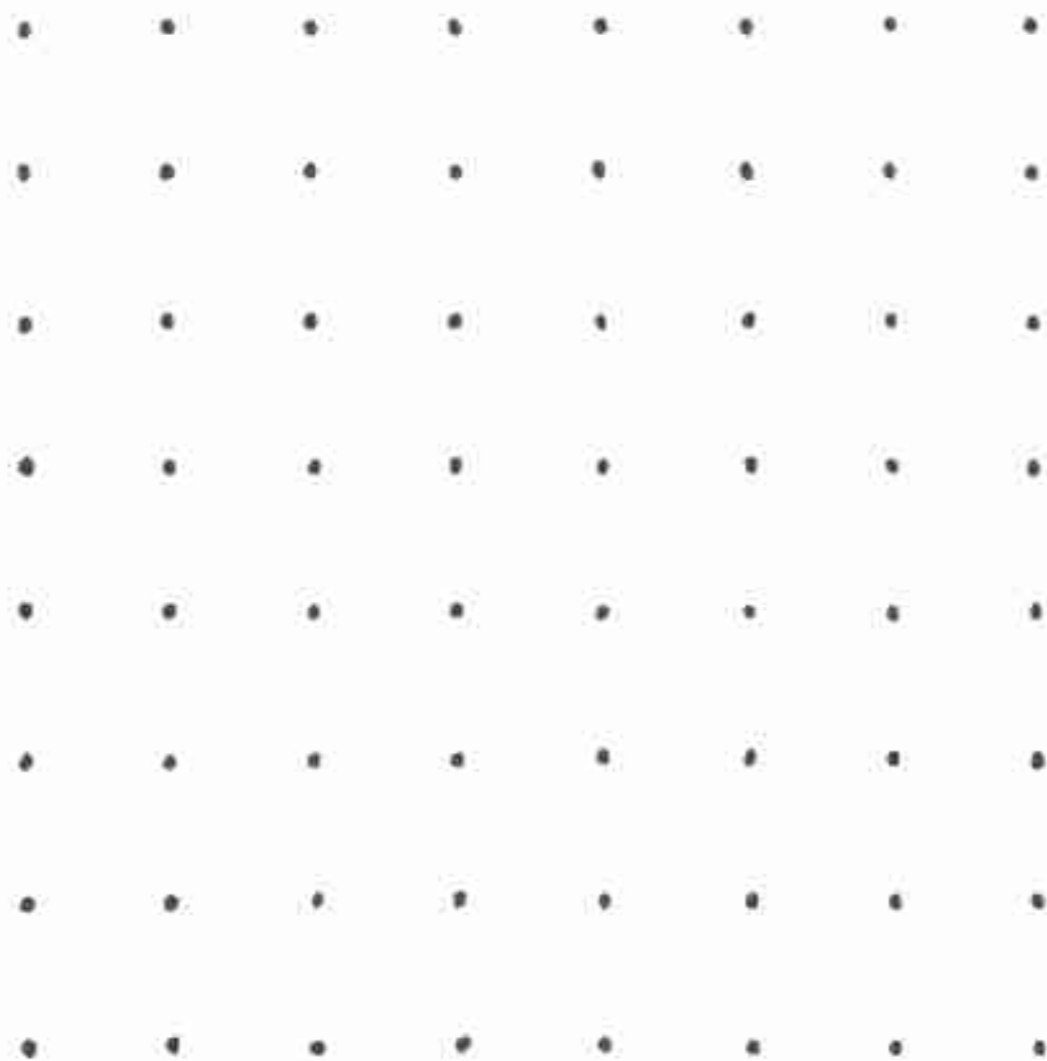

You must try to draw your lines so as to keep the other player from making more boxes than you do. (If you want to play more games, make it on scrap paper.)

Diploma

This is to certify that

(write your name)

(write your address)

has been *graduated* from this
book of coloring and
puzzles and, furthermore,
has flown in a PSA
Super Jet.



(Date)

